

SERIES	MODEL	CONFIGURATION	SEAL TYPE
Max-Series	M8	Sealed or Mag-Drive Gear Pump Close-Coupled with RF Flanges.	Single or Double Mechanical Seal or Mag-Drive (Sealless)

UNITS: inches [mm]

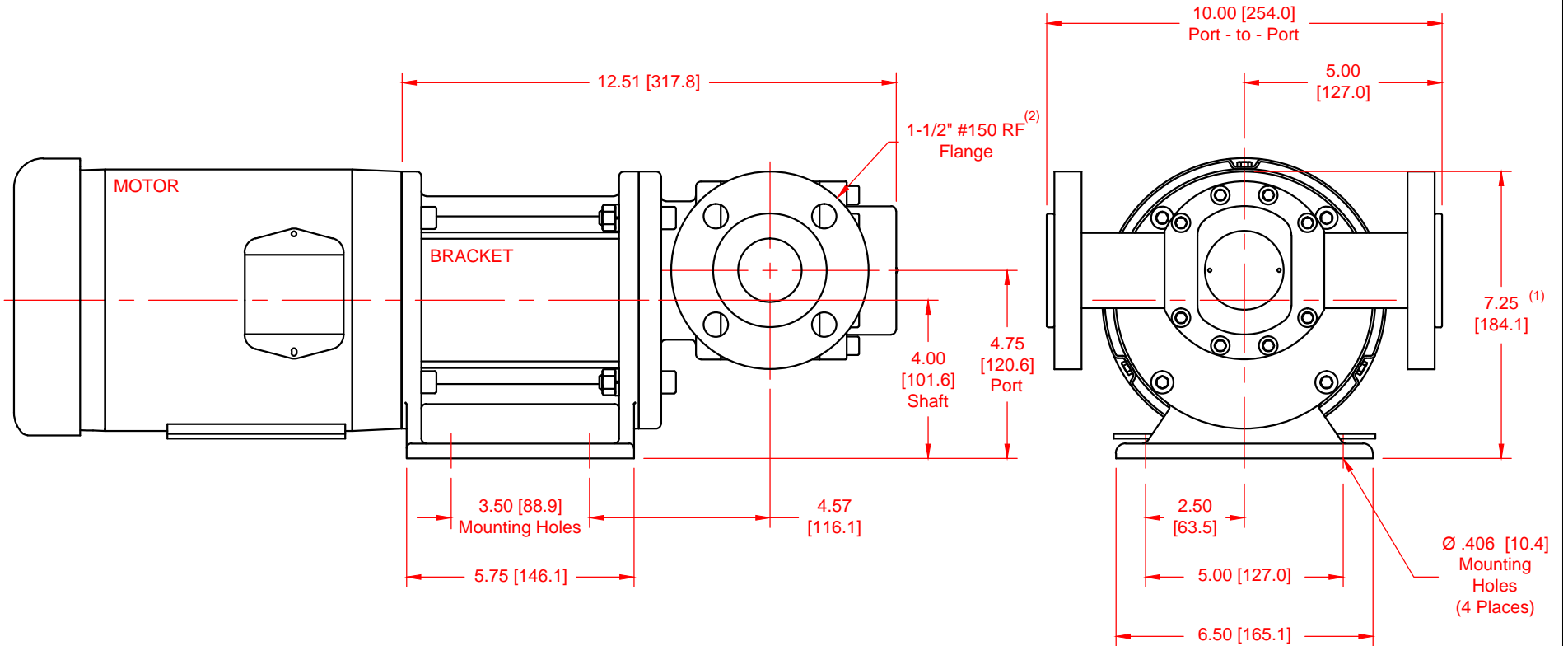

NOTES:

- 1) Dimension to top of Bracket.
- 2) Also available with ANSI 1-1/2" #300 RF and DN40 PN16 flanges.